

BATTERY MODULE

- 24V, 7Ah Battery Capacity (2x 12V Batteries in Series)
- Small Mounting Footprint
- 2m Power Leads Included
- PT1000 Sensor for Battery Module Temperature Included
- Includes a Center-tap Terminal with Auto-resettable Fuse
- 3 Year Warranty, Except for Batteries, Which Are Considered a Service Part.

1. GENERAL DESCRIPTION

The UZK24.071 battery module utilizes two non-spillable maintenance-free VRLA lead-acid batteries (connected in series), that are assembled in one package with all the required wiring included.

The battery module is available in two different options. It can be ordered as UZK-module with a battery or as UZO-module without a battery which can be installed at a later date to avoid outdated batteries.

The battery module also includes a sensor board, which contains a temperature sensor and a center-tap connection terminal. The use of the sensor board enables to monitor and charge the two batteries individually and precisely, which extends the service life of the batteries and makes the use of matched replacement batteries unnecessary. The use of the sensor board is optional, the DC-UPS will also function without the sensor board installed.

2. SHORT-FORM DATA

Nominal voltage	DC 24V	
Nominal battery capacity	7Ah	
Nominal battery life	3 to 5 years	According EUROBAT
Battery current	Max. 35A	Discharging current
	Max. 1.8A	Charging current
Temperature sensor	PT1000	
Recommended charging voltage	27.8V	At 10°C
	27.5V	At 20°C
	27.15V	At 30°C
	26.8V	At 40°C
Self-discharge rate	3%/month At 20°C	
Battery fuse	35A	ATOF® 287 035 from Littelfuse
Temperature range	-10°C to +40°C	For charging
	-15°C to +50°C	For discharging
Size (WxHxD)	137x186x124mm	
Weight	6200g / 13.7lb	For UZK24.071
	800g / 1.76lb	For UZO24.071

3. ORDER NUMBERS

Battery Module UZK24.071	Battery module with assembled batteries
UZO24.071	Battery module without assembled batteries
UZB12.071	Battery replacement 12V, 7Ah 2pcs needed for one battery module

4. MARKINGS



INDEX

	Page		Page
1. General Description	1	12. Environment	6
2. Short-form Data	1	13. Sensor Board.....	6
3. Order Numbers.....	1	14. Terminals and Wiring.....	7
4. Markings.....	1	15. Protection Features	7
5. Intended Use	3	16. Approvals.....	8
6. Instructions for Disposal of the Batteries.....	3	17. Other Fulfilled Standards.....	8
7. Instructions for Battery Storage	3	18. Physical Dimensions and Weight.....	9
8. Installation Instructions	3	19. Recommendations for a Long Battery Life	10
9. Hazardous Location Installation Instructions.....	4	20. Mounting Orientations	11
10. Instructions for Replacing Batteries	5		
11. Functional Diagram.....	5		

The information given in this document is correct to the best of our knowledge and experience at the time of publication. If not expressly agreed otherwise, this information does not represent a warranty in the legal sense of the word. As the state of our knowledge and experience is constantly changing, the information in this data sheet is subject to revision. We therefore kindly ask you to always use the latest issue of this document (available under www.pulspower.com).

No part of this document may be reproduced or utilized in any form without our prior permission in writing.

⚠ WARNING Risk of electrical shock, fire, personal injury or death.

- Turn power off before working on the device. Protect against inadvertent re-powering.
- Do not modify or repair the unit.
- Use caution to prevent any foreign objects from entering the housing.
- Do not use in wet locations or in areas where moisture or condensation can be expected.
- Do not touch during power-on, and immediately after power-off. Hot surfaces may cause burns.

5. INTENDED USE

This module is designed for installation in an enclosure and is intended for the general professional use such as in industrial control, office, communication, and instrumentation equipment.

Do not use this module in equipment, where malfunction may cause severe personal injury or threaten human life.

6. INSTRUCTIONS FOR DISPOSAL OF THE BATTERIES

Batteries must be completely discharged before replacement and can be returned to the supplier of the battery module or the battery manufacturer for disposal.

Always dispose batteries through a recycling organization.

7. INSTRUCTIONS FOR BATTERY STORAGE

Do not store batteries or battery modules at temperatures higher than 25°C or performance and lifetime may change.

Do not store discharged batteries. Keep batteries fully charged!

Charge retention is important to get the longest battery life. Stored batteries which are not fully charged age faster than charged batteries.

Do not store batteries longer than 9 months without charging or performance and lifetime may change. Every 9 months or whenever the open circuit voltage (OCV) falls below 25.2V, the battery module should be charged. Apply a charging voltage of 27.6V (at 25°C) for 72 hours. Batteries with an OCV below 24V must not be charged anymore and must be disposed.

8. INSTALLATION INSTRUCTIONS

This device may only be installed and put into operation by qualified personnel.

Before initial use, check the last charging which is marked on the battery. If it is older than 9 month, replace the battery.

Do not install the battery fuse until the installation work is complete.

This device does not contain serviceable parts, except the fuse or replacement battery. If malfunction should occur during installation or operation, first check the fuse and battery for proper functionality. If the unit is damaged or if the malfunction continues, immediately turn power off and send device to the factory for inspection.

Replacement fuses must be of the same type or an UL listed fuse with the same nominal value and characteristics.

Do not short-circuit the battery poles or power wires and always check correct battery polarity.

Mount the device on a flat surface.

Do not install the battery module upside down.

Place the battery module in a cool area inside a cabinet.

Shorten the (+) and (-) wires as needed for the DC-UPS between the battery module and the DC-UPS. If separate wires are used, do not use wires smaller than 4mm² (12 AWG).

Connect the sensor board to the DC-UPS by using control wires with a minimum wire size of 0.5mm² / 20AWG.

Install the device in an enclosure providing protection against electrical, mechanical and fire hazards. Ensure sufficient ventilation by following the requirements of the EN 50272-2.

CAUTION: The unit contains wet cell batteries. Ventilation of the installation room in accordance with the rules of Canadian Electrical Code, part 1 is required if used in Canada.

The battery module is for use in a controlled environment. Do not use the device in pollution degree 3 areas without additional protection or in applications where a degree of protection better than IP00 is required.

Do not use batteries other than the original batteries supplied by the manufacturer to avoid conflicts with agency approvals.

The maximum surrounding air temperature is +50°C / +122°F. The operational temperature is the same as the ambient or surrounding air temperature and is defined as the air temperature 2cm below the device.

Fig. 8-1 **Wiring scheme**

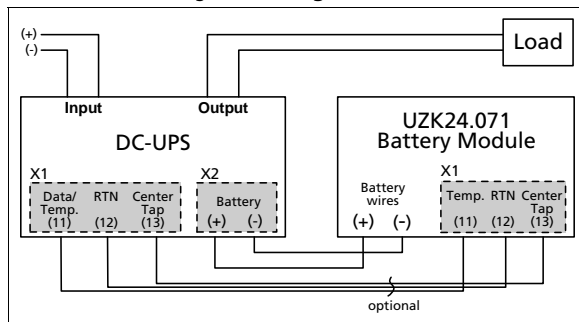

9. HAZARDOUS LOCATION INSTALLATION INSTRUCTIONS

The device is suitable for use in Class I Division 2 Groups A, B, C, D locations and for use in Group II Category 3 (Zone 2) environments.

ATEX Certificate: EPS 15 ATEX 1 025 X
ATEX Classification: II 3G EX ec IIC T4 Gc

WARNING EXPLOSION HAZARDS!

Substitution of components may impair suitability for this environment. Do not disconnect the device unless power has been switched off or the area is known to be non-hazardous.

A suitable enclosure must be provided for the end product which has a minimum protection of IP23 and fulfils the requirements of the EN 60079-15. Sufficient ventilation must be ensured in the final installation.

Do not use batteries other than the original batteries supplied by the manufacturer or batteries, which are approved according to EN/ IEC 60079-7.

10. INSTRUCTIONS FOR REPLACING BATTERIES

Batteries need to be replaced periodically. The time interval depends on the ambient temperature in which the battery is used and on the number and depth of discharge cycles. In a typical application it is recommended to replace the batteries at least every 2 years.

Disconnect battery fuse before replacing the battery.

Regarding disposal of used batteries see chapter 6.

11. FUNCTIONAL DIAGRAM

Fig. 11-1 Functional diagram battery module with sensor board

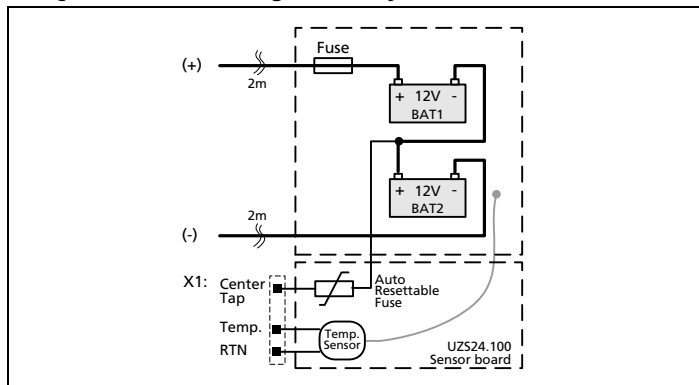

12. ENVIRONMENT

Operational temperature *)	-10°C to +40°C (14°F to 104°F)	For charging Frequently charging below +5°C (41°F) reduced the lifetime of the battery
	-15°C to +50°C (5°F to 122°F)	For discharging
Storage temperature	-20°C to +50°C (-4°F to 122°F)	For storage and transportation Recommendation: Do not store at temperatures higher than 25°C or performance and lifetime may change.
Humidity	5 to 95% r.h.	IEC 60068-2-30 Do not energize while condensation is present
Vibration sinusoidal	±4mm at 16.7Hz fixed frequency for 1hour	Vibration in vertical mounting orientation according to IEC/EN 61056-1
Shock	free fall from 20cm onto a wooden floor	Shock with bottom down orientation according to IEC/EN 61056-1
Altitude	0 to 6000m (0 to 20 000ft)	
Degree of pollution	2	According to IEC 62477-1, not conductive
LABS compatibility	The unit does not release any silicone or other LABS-critical substances and is suitable for use in paint shops.	
Corrosive gases	ISA-71.04-1985, Severity Level G3	

*) Operational temperature is the same as the ambient temperature and is defined as the air temperature 2cm below the unit.

13. SENSOR BOARD

The battery module includes a monitoring and protection board. This board contains a temperature sensor and a center-tap connection with an auto-resettable fuse to protect the center-tap wire between the battery module and the DC-UPS control unit.

The use of the sensor board enables to monitor and charge the two batteries individually and precisely, which extends the service life of the batteries and makes the use of matched replacement batteries unnecessary.

The use of the sensor board is optional, the DC-UPS will also function without the sensor board installed.

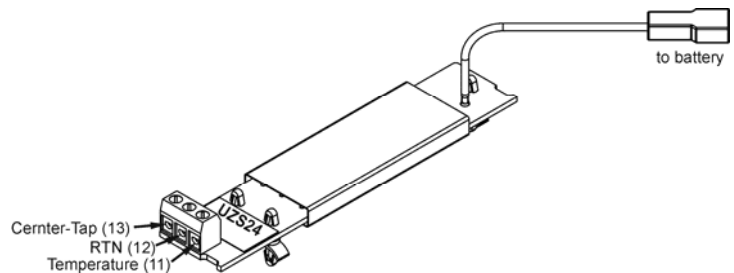

14. TERMINALS AND WIRING

The terminals are IP20 Finger safe constructed and suitable for field- and factory wiring.

Signal and center tap terminals

Type	Screw terminals
Maximal wire size, solid wire	1.5mm ²
Maximal wire size, stranded wire	1.5mm ²
American Wire Gauge	AWG 26-14
Maximal wire diameter	1.5mm (including ferrules)
Wire stripping length	6mm / 0.25inch
Screwdriver	Slotted 3x0.5mm
Recommended tightening torque	0.45Nm, 4lb.in

Instructions:

- a) Follow national installation codes and installation regulations!
- b) Ensure that all strands of a stranded wire enter the terminal connection!
- c) Unused terminal compartments should be securely tightened.
- d) Ferrules are allowed.

15. PROTECTION FEATURES

Degree of protection	IP 00	According to EN/IEC 60529
Class of protection	III	According to EN/IEC 61140
Internal input fuse	35A	DC-Fuse (blade type) ATOF® 287 035 from Littelfuse Replacement fuses must be of the same type or an UL listed fuse with the same nominal value and characteristics.
Isolation	1100Vac	Isolation voltage between power to chassis

16. APPROVALS

EC Declaration of Conformity		The CE mark indicates conformance with the - EMC directive and the - ATEX directive
UL 508		Listed for use as Industrial Control Equipment; U.S.A. (UL 508) and Canada (C22.2 No. 107-1-01); E-File: E198865
ANSI / ISA 12.12.01-2015 Class I Div 2		Recognized for use in Hazardous Location Class I Div 2 T3 Groups A,B,C,D systems; U.S.A. (ANSI / ISA 12.12.01-2015) and Canada (C22.2 No. 213-M1987)
EN 60079-0, EN 60079-7 ATEX	 II 3G Ex ec IIC T4 Gc	Approval for use in hazardous locations Zone 2 Category 3G. Number of ATEX certificate: EPS 15 ATEX 1 025 X The battery module must be built-in in an IP23 enclosure.
IEC 60079-0, IEC 60079-7	IECEX	Suitable for use in Class 1 Zone 2 Groups IIa, IIb and IIc locations. Number of IECEx certificate: IECEx EPS 15.0049X
Marine		GL (Germanischer Lloyd) classified Environmental category: A Marine and offshore applications
EAC TR Registration		Registration for the Eurasian Customs Union market (Russia, Kazakhstan, Belarus)

17. OTHER FULFILLED STANDARDS

RoHS Directive	RoHS ✓	Directive 2011/65/EU of the European Parliament and the Council of June 8 th , 2011 on the restriction of the use of certain hazardous substances in electrical and electronic equipment. Note: Batteries are exempt from the directive. The directive only applies to the remaining assembly parts of the battery module.
REACH Directive	REACH ✓	Directive 1907/2006/EU of the European Parliament and the Council of June 1 st , 2007 regarding the Registration, Evaluation, Authorisation and Restriction of Chemicals (REACH)

18. PHYSICAL DIMENSIONS AND WEIGHT

Width	137mm / 5.40"	
Height	186mm / 7.32"	
Depth	124mm / 4.88"	
Weight	6200g / 13.7lb	For UZK24.071
	800g / 1.76lb	For UZO24.071
Bracket material	Zinc-plated steel	

Fig. 18-1 **Front view**

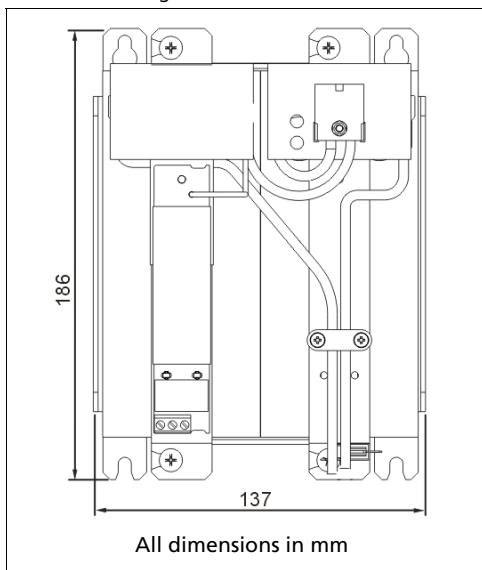

Fig. 18-2 **Side view**

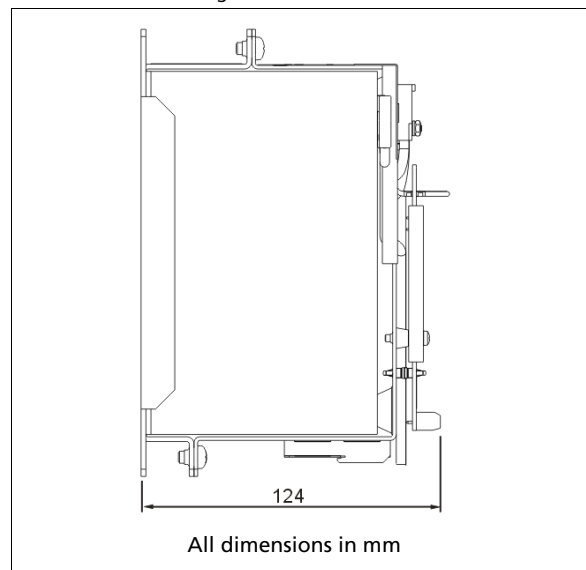

Fig. 18-3 **Isometric view**

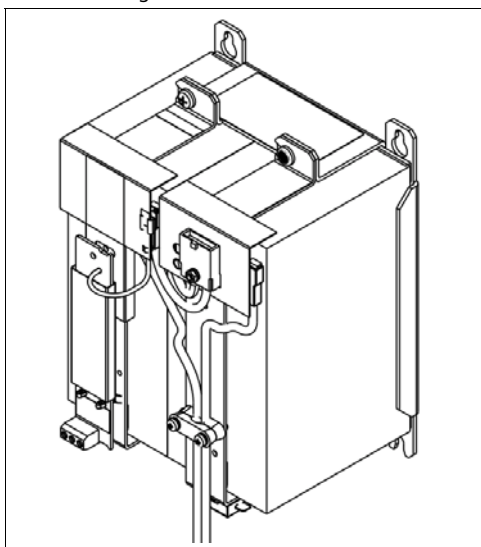
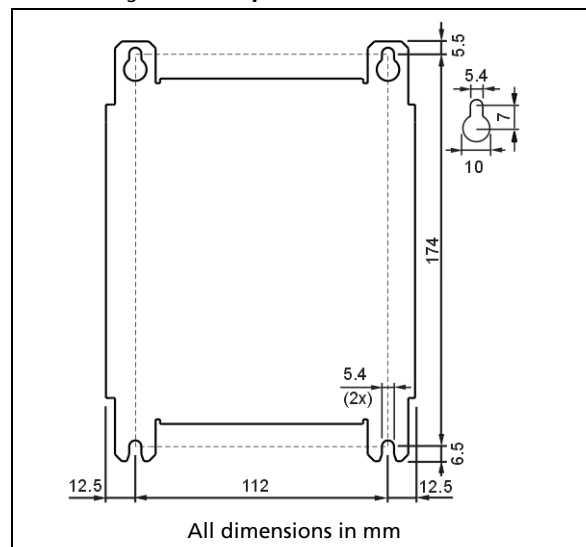

Fig. 18-4 **Hole pattern for wall mount**



19. RECOMMENDATIONS FOR A LONG BATTERY LIFE

Temperature:

The temperature has the most impact on the service life. The hotter the temperature, the earlier the wear-out phase of the battery begins. The wear-out results in a degradation of battery capacity. Place the battery module in a cool location, e.g. near the bottom of the control cabinet. Do not place the battery module near heat generating devices. Do not overcharge batteries!

Fig. 19-1 Service life (according to EUROBAT) vs. ambient temperature, typ.

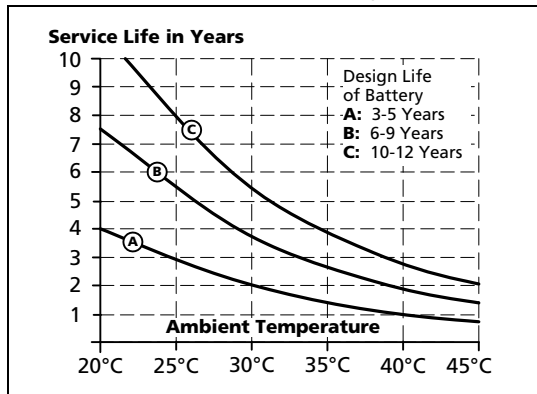

Number of discharge cycles and depth of discharge:

Do not discharge batteries more than necessary. Set buffer time limiter to the required buffer time. The number, as well as the depth of discharging cycles is limited. A replacement of the battery might be necessary earlier.

When choosing the battery capacity, always try to get the next higher capacity than required. The depth of discharge reduces the service life of the battery and limits the number of cycles.

Fig. 19-2 Battery degradation vs. discharging cycles, typ.

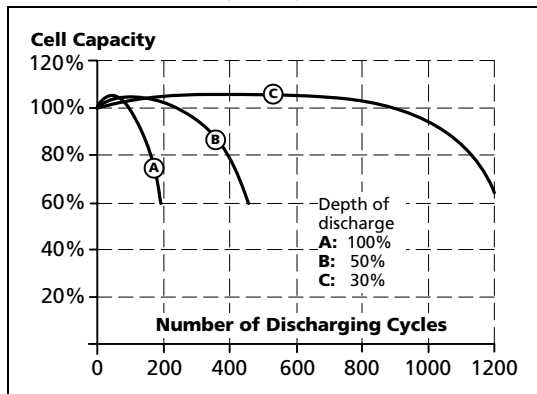

Store batteries fully charged

Do not store discharged batteries. Keep batteries fully charged!

Charge retention is important to get the longest battery life. Stored batteries which are not fully charged age faster than charged batteries. Batteries which are not in use should be recharged at least once a year. The higher the ambient temperature, the shorter the charging interval. At storage temperatures higher than 30°C, recharging should be done at least every nine months.

20. MOUNTING ORIENTATIONS

The standard mounting orientation is the vertical installation onto a flat surface.

Fig. 20-1 **Standard mounting orientation**

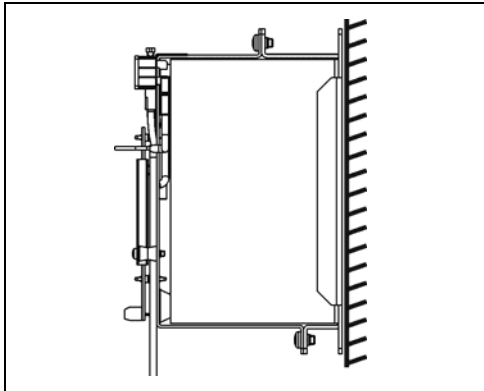

The following mounting orientations are also allowed:

Fig. 20-2 **Allowed mounting orientation**

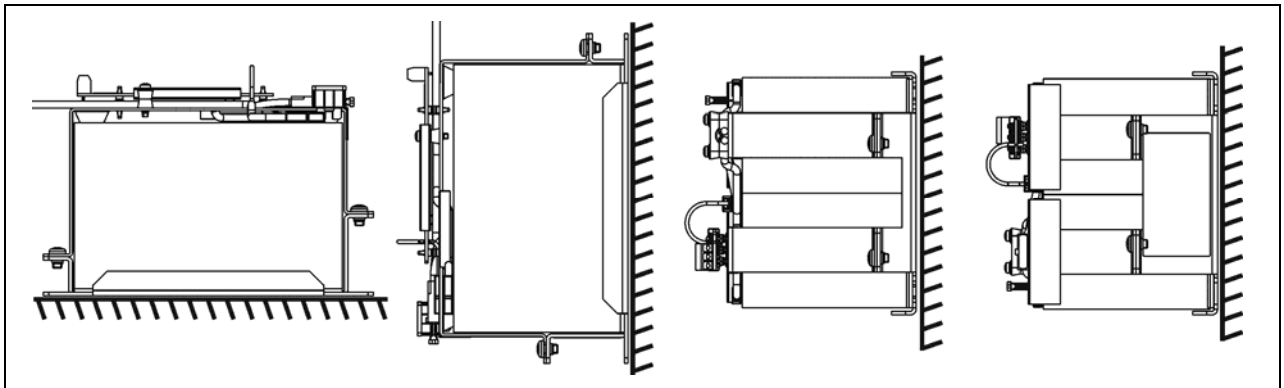

Do not use the battery module in an upside down position:

Fig. 20-3 **Forbidden mounting orientation**

